

3	280V	310V											
---	------	------	--	--	--	--	--	--	--	--	--	--	--

③ Rated capacitance value(Digit 6 to 8)

According to JIS

101=10x10¹ pF=0.1nF 102=10x10² pF=1.0nF= 0.001uF 103=10x10³ pF=10nF=0.01uF
 104=10x10⁴ pF=100nF=0.1uF 105=10x10⁵ pF=1000nF=1uF 106=10x10⁶ pF=10000nF=10uF
 107 =100uF 108 =1000uF 109 =10000uF

④ Capacitance tolerance (Digit 9)

Tolerance	± 1%	± 2%	± 3%	± 5%	±10%	±15%	± 20%	0~+10%	0~-10%		
Code	F	G	H	J	K	L	M	T	P		

⑤ Pitch/ Length of Axial products (Digit 10)

Pitch	3.5	4.0	4.5	5.0	5.5	6.0	6.5	7.0	7.5	10.0	12.5	15.0	20.0
Code	A	B	C	D	E	F	G	H	J	K	L	M	N
Pitch	22.0	22.5	25.0	27.0	27.5	30.0	31.0	32	37	26	8		
Code	P	Q	R	S	T	U	V	W	X	Y	1		
Pitch	15	19	21	27	32	37	42	46	24	50	56		
Code	1	2	3	4	5	6	7	8	9	A	B		

*When the products are axial products, it stands for the length of the products

⑥ Lead (Digit 11)

Lead	CP 0.5	CP 0.6	CP 0.7	CP 0.8	CU 1.0	CU 0.8						
code	5	6	7	8	1	9						

⑦ Package type and code of Lead Configuration(Digit 12)

Code	Description
S	Straight lead , Cut lead
K	Bent lead
T	Taping package

⑧ Internal use (Digit 13 ~ 18)

2 Features

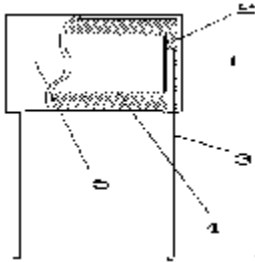
Product name	Metalized Polyester Film Capacitor(Mini-Box Type)								
Reference Standard	GB/T 2693 (IEC 60384-1) GB/T 7332 (IEC 60384-2)								
Construction	 <ol style="list-style-type: none"> 1. Metalized polyester film 2. Metal spray layer 3. lead 4. Flame retardant Epoxy resin 5. Flame retardant Plastic casing 								
Atmospheric conditions IEC 68-1	<table border="0" style="width: 100%;"> <tr> <td>Standard atmospheric conditions (IEC 68-1-5.3)</td> <td>Base condition (IEC 68-1-5.1)</td> </tr> <tr> <td>Temperature : 15°C ~ 35°C</td> <td>Temperature : 20°C</td> </tr> <tr> <td>Humidity : 25% ~ 75%</td> <td>Atmospheric pressure : 101.3KPa</td> </tr> <tr> <td>Atmospheric pressure : 86KPa ~ 106KPa</td> <td></td> </tr> </table>	Standard atmospheric conditions (IEC 68-1-5.3)	Base condition (IEC 68-1-5.1)	Temperature : 15°C ~ 35°C	Temperature : 20°C	Humidity : 25% ~ 75%	Atmospheric pressure : 101.3KPa	Atmospheric pressure : 86KPa ~ 106KPa	
Standard atmospheric conditions (IEC 68-1-5.3)	Base condition (IEC 68-1-5.1)								
Temperature : 15°C ~ 35°C	Temperature : 20°C								
Humidity : 25% ~ 75%	Atmospheric pressure : 101.3KPa								
Atmospheric pressure : 86KPa ~ 106KPa									
Technology Specifications	<p>Climatic category : 55/105/56</p> <p>Upper temperature : 85°C</p> <p>Operating Temperature Range : -55°C ~ 105°C (+85°C to +105°C:decreasing factor 1.25% per °C for Vr (DC))</p> <p>Rated Voltage : 50/63V、100V、160V、250V、400V</p> <p>Capacitance Range : 0.001μF~1.0μF</p> <p>Capacitance Tolerance : ±5% (J) ; ±10% (K)</p> <p>Voltage Proof : 1.4U_R (5s)</p> <p>Dissipation Factor : ≤1.0% (20°C , 1KHz)</p> <p>Insulation Resistance : U_R≤100V ≥3750MΩ ; C_R≤0.33μF ≥1250S ; C_R>0.33μF (20°C , 10V,1min)</p> <p>U_R>100V ≥75000MΩ ,C_R≤0.33μF ≥2500S ; C_R>0.33μF (20°C , 100V,1min)</p>								

Terminal Strength IEC 68-2-21	Tension	Dia. (mm)	Tension	Bend	Dia. (mm)	Load
		0.3 < d ≤ 0.5	5N		0.3 < d ≤ 0.5	2.5N
		0.5 < d ≤ 0.8	10N		0.5 < d ≤ 0.8	5N
		0.8 < d ≤ 1.25	20N		0.8 < d ≤ 1.25	10N
Time duration : 10±1second Bending for twice in two direction After above test, no visible damage.						
Solder ability IEC 68-2-20	Soldering temperature : 235°C±5°C Immersion duration : 2.0s±0.5s Good Tinning					
Soldering heat IEC 68-2-20	Soldering temperature : 260°C±5°C Immersion duration : 10s±1s Dip depth from the mounting surface 2+0/-0.5mm, using the thickness of 1.5mm ± 0.5mm insulation shielding plate Capacitance change : Δ C/C : ≤ ± 2% DF change : Δtan δ : ≤ 0.3% at 1 KHZ					
Temperature Cycling IEC 68-2-14	Temperature: θ A = -55°C ; θ B = +105°C Time duration : 30min ; Cycle times : 5 times ; Capacitance change : Δ C/C : ≤ ±5% of the value before test. DF change : Δtan δ : ≤ 0.3% at 1 KHZ Insulation Resistance : ≥50% of the value before test.					
Vibration IEC 68-2-6	Frequency : 10 ~ 500Hz Direction and Duration: Per direction 2hrs , Total 6hrs ; Amplitude 0.75mm OR acceleration 98m/s ² (Taking the severity of lower) No visible damage and deterioration in appearance					
Bump IEC 68-2-29	Bump times : 4000 times Acceleration : 390m/s ² Pulse duration : 6ms No visible damage and deterioration in appearance					
Climatic Sequence	Dry heat IEC 68-2-2	Temperature : +105°C Duration : 16hs				No breakdown or flashover ; No visible damage and deterioration in appearance and the marking shall be legible
	Damp heat cycle	Test Db, Severity b, the first cycle				
	Cold IEC 68-2-1	Temperature : -55°C duration : 2h				

	<p>Low Air pressure IEC 68-2-13</p>	<p>Temperature : 15°C—35°C Pressure : 8.5KPa Duration : 1h apply UR at the last 1 minute.</p>	<p>Capacitance change : $\Delta C/C : \leq \pm 5\%$ DF change : $\Delta \tan \delta : \leq 0.3\%$ at 1 KHZ . Insulation Resistance: $\geq 50\%$ of the value before test</p>
	<p>Damp heat cycle IEC 68-2-30</p>	<p>Test Db, Severity b, the other cycles, apply UR for 1minute after the test finished.</p>	
<p>Damp Heat Test IEC 68-2-3</p>	<p>Temperature : 40°C $\pm 2^\circ\text{C}$ Humidity : 93 +2/-3 % Duration : 21 days No visible damage and deterioration in appearance and the marking shall be legible Capacitance change : $\Delta C/C : \leq \pm 5\%$ DF Change : $\Delta \tan \delta : \leq 0.5\%$ at 1 KHZ Insulation Resistance: $\geq 50\%$ of the value before test</p>		
<p>Durability</p>	<p>Temperature : +85°C Voltage : 1.25U_R Duration: 1000Hrs No visible damage and deterioration in appearance and the marking shall be legible Capacitance change : $\Delta C/C : \leq \pm 8\%$ DF change : $\Delta \tan \delta : \leq 0.5\%$ at 1 KHZ Insulation Resistance: $\geq 50\%$ of the value before test</p>		
<p>Charge & Discharge</p>	<p>Charging Times : 10000 times Charging Voltage : U_R Charging duration : 0.5s Discharging duration : 0.5s Charging resistance : $220/C_R \Omega$ C_R: rated capacitance (μF) Discharging resistance : $R=10/CR(\Omega)$ or 20Ω(Whichever is greater) CR: rated Capacitance (μF) Capacitance change : $\Delta C/C : \leq \pm 5\%$ DF change : $\Delta \tan \delta : \leq 0.3\%$ at 1 KHZ Insulation Resistance: $\geq 50\%$ of the value before test</p>		

2 Soldering Temperature VS Time

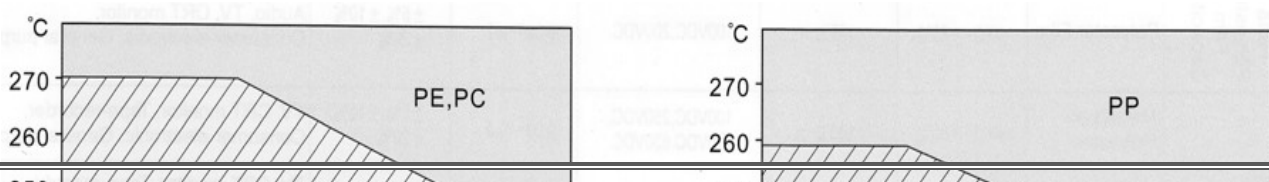

2 Temperature Characteristics

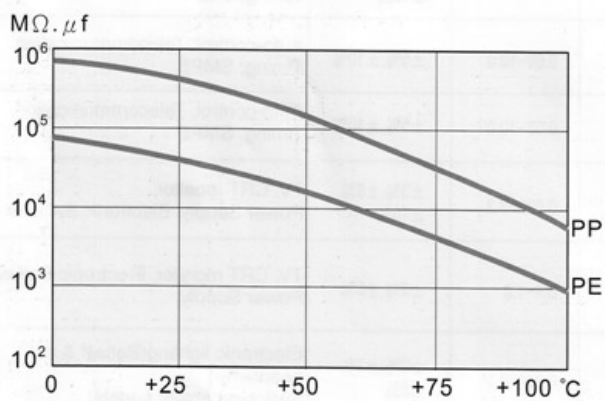
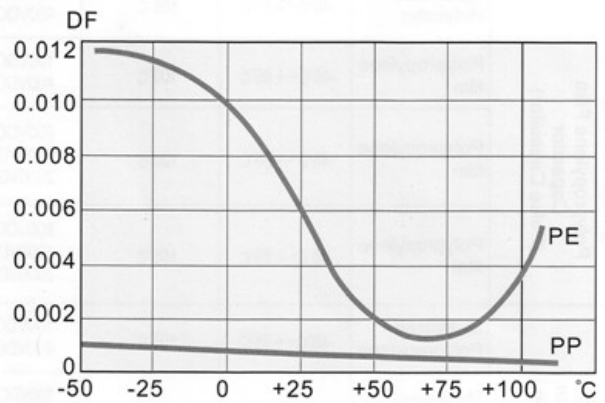
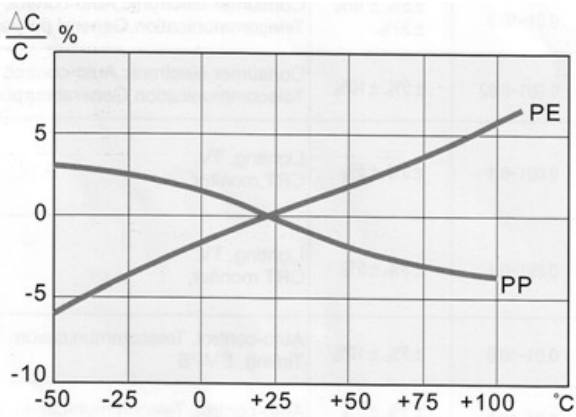

PP: 聚丙烯薄膜 (Polypropylene Film)

PE: 聚酯薄膜 (Polyester Film)

2 Frequency Characteristics

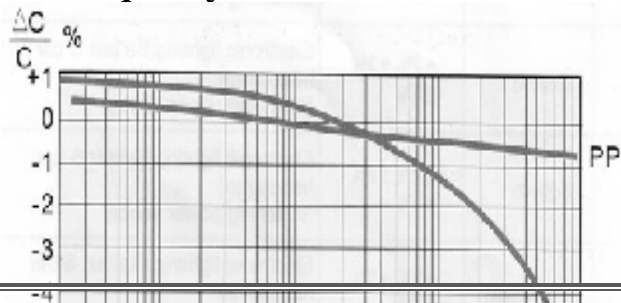

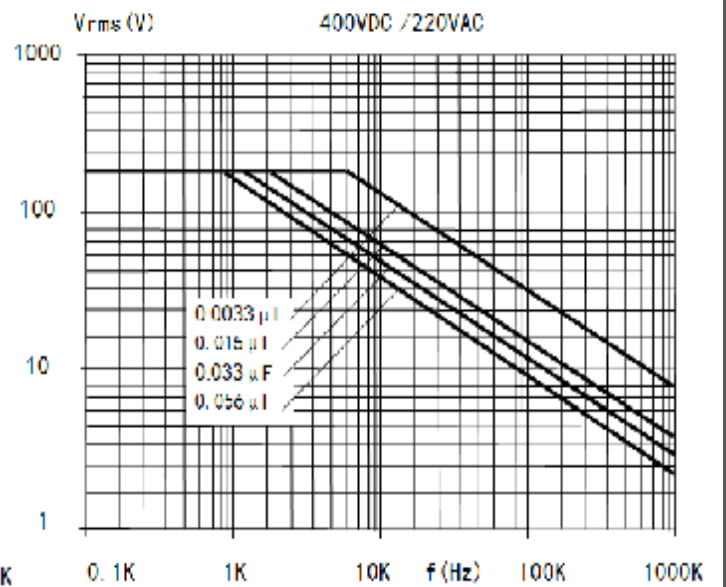
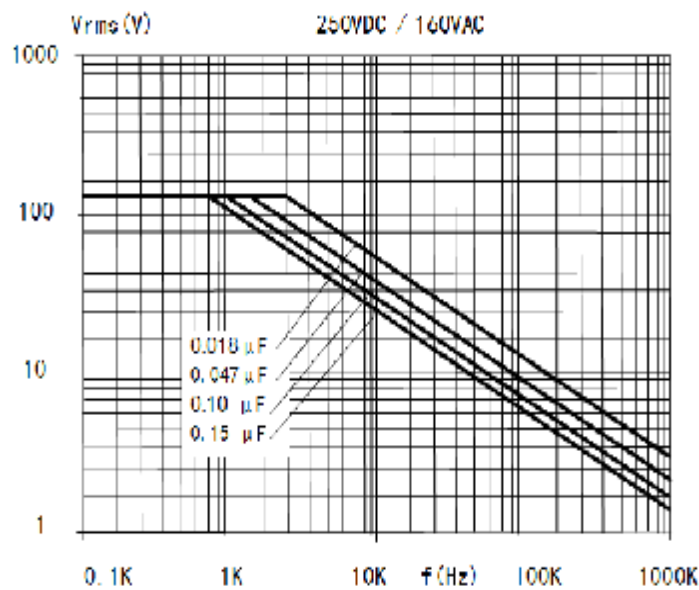
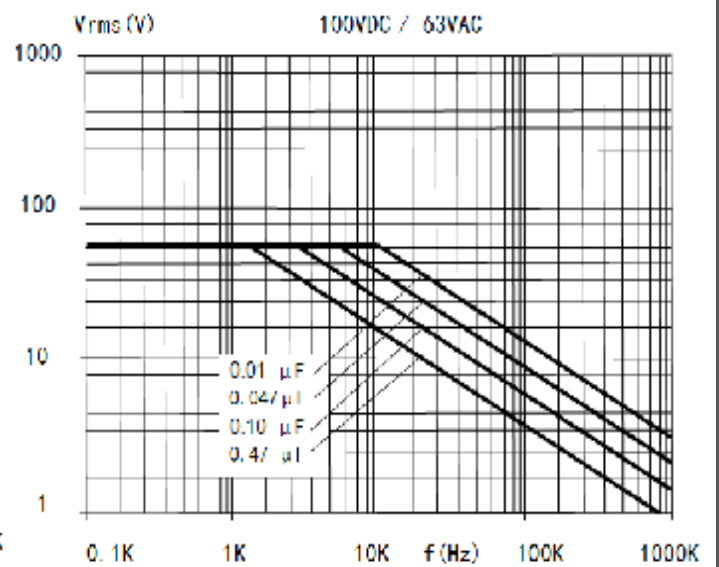
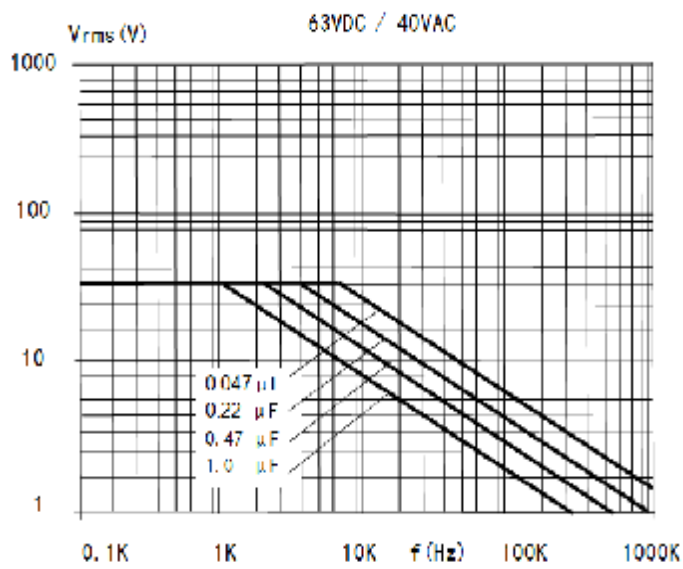

2 标志说明 Marking Specification

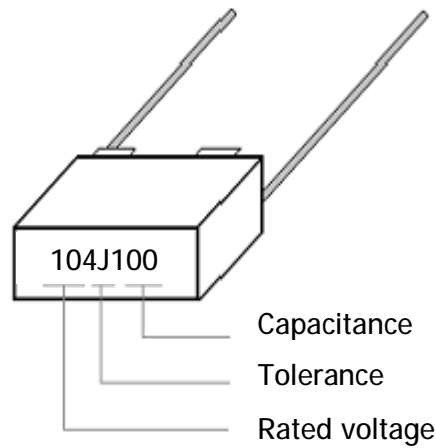

2 Taping Drawing & Dimensions

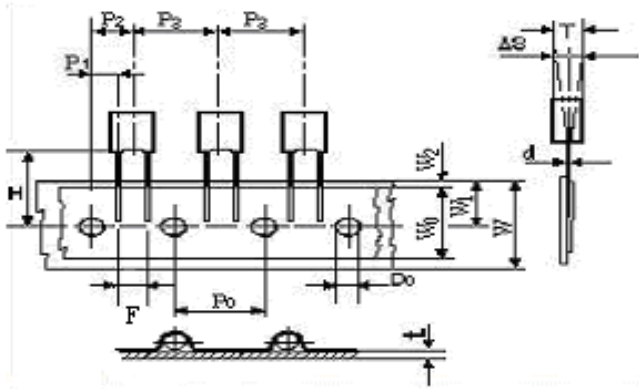

Fig.1

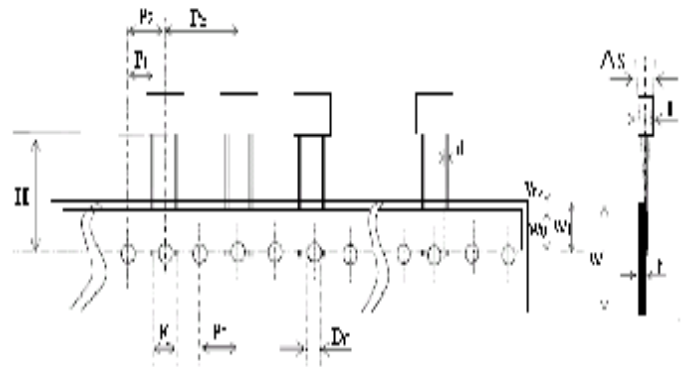
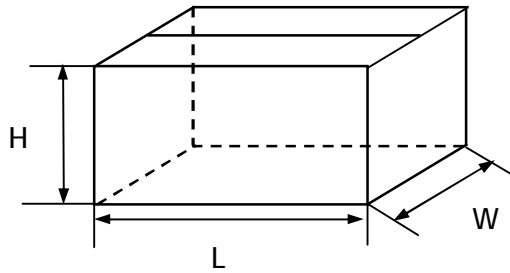

Fig.2

Technique Data	Code	Size (mm)					Technique Data	Code	Size (mm)				
		P=5	P=7.5	P=10	P=15	Tolerance			P=5	P=7.5	P=10	P=15	Tolerance
Taping Type		Fig1	Fig1	Fig2	Fig2		Taping Type		Fig1	Fig1	Fig2	Fig2	
Section distance	P3	12.7	12.7	25.4	25.4	±1.0	Tape width	W	18.0	18.0	18.0	18.0	±0.5
Distance between two hole	P0	12.7	12.7	12.7	12.7	±0.3	Jack position	W1	9.0	9.0	9.0	9.0	±0.5
Leads position	P1	3.85	2.6	7.7	5.2	±0.7	Bending height	H0	16	16	16	16	±0.5
Pitch for forming type	F	5.0	7.5	10.0	15.0	±0.5	Upper size	H1	39	39	39	39	max
Body position	P2	6.35	6.35	12.7	12.7	±1.3	Dia. Of the hole	Do	4.0	4.0	4.0	4.0	±0.3
Product Inclination	Δ S	0	0	0	0	±0.2	Tape thickness	t	0.7	0.7	0.7	0.7	±0.2

2 Carton Size



Out packaging box for bulk

L: 480mm

W: 320mm

H: 280mm

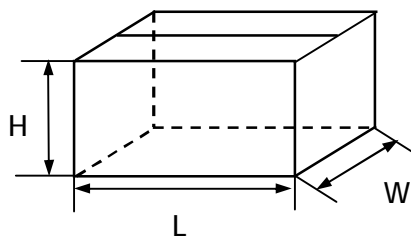

Inner packing box for bulk

L: 280mm

W: 225mm

H: 120mm

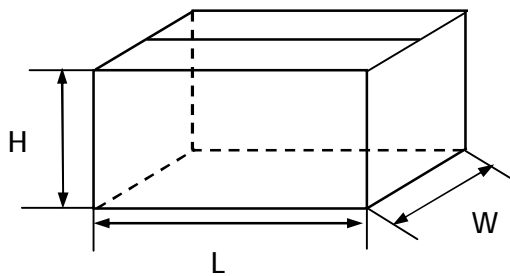

Out packaging box for taping

L: 640mm

W: 360mm

H: 290mm

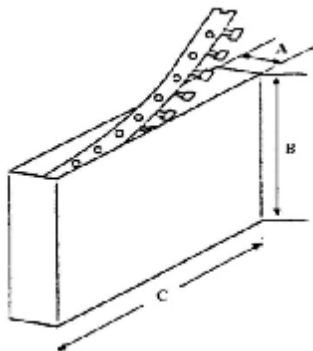

Inner packing box for taping

A: 50mm

B: 320mm

C: 330mm