

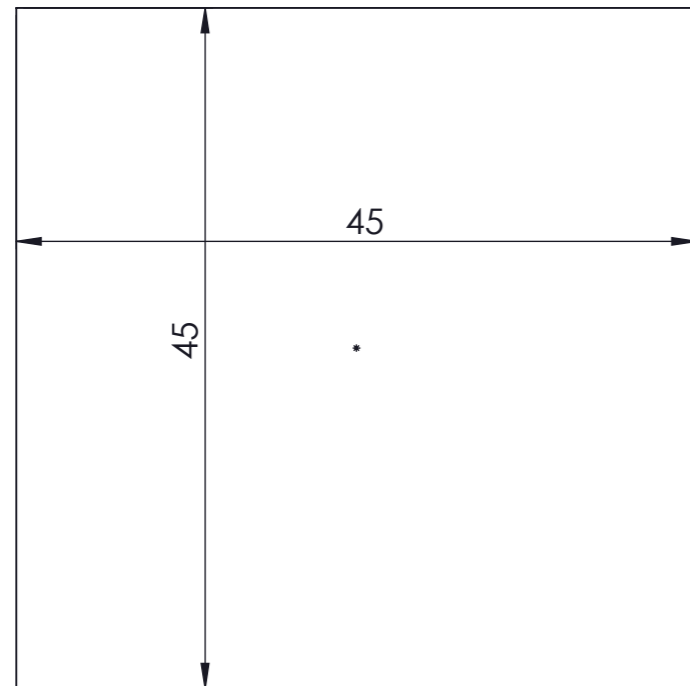



### Mounting Detail



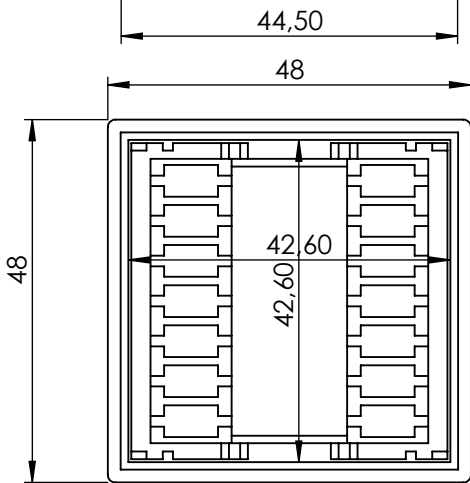
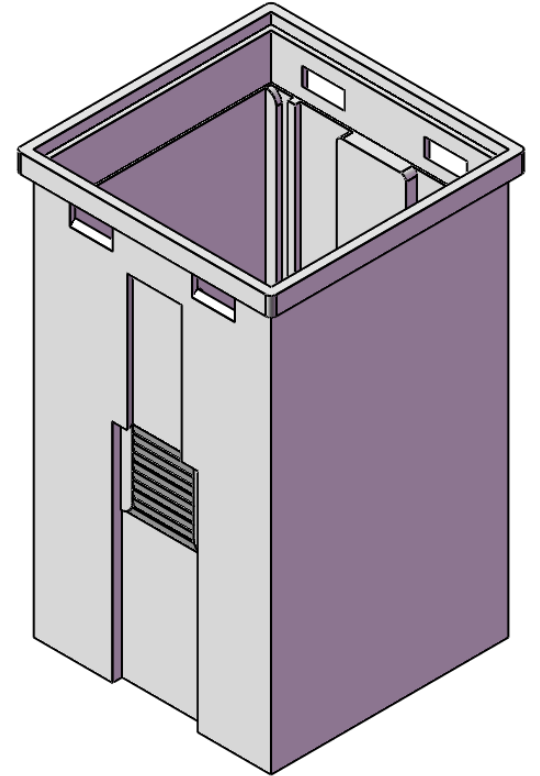
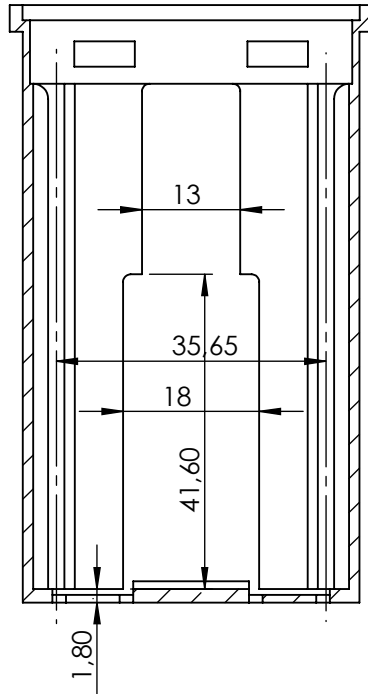
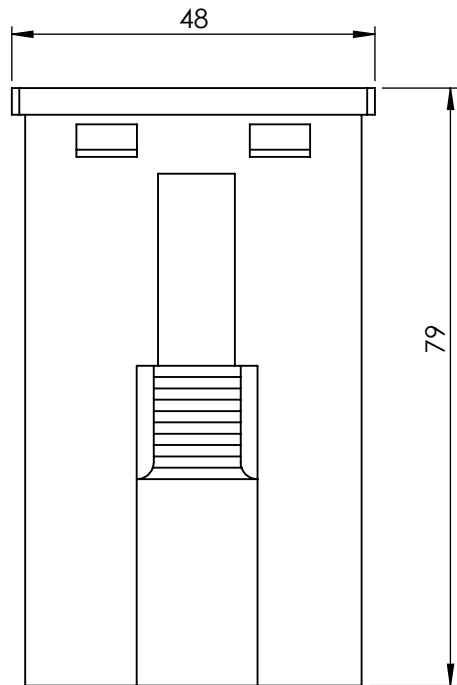

- 0,5  
+ 0,50

|  |  |   |   |
|--|--|---|---|
| <small>PROPRIETARY AND CONFIDENTIAL<br/>THE INFORMATION CONTAINED IN THIS<br/>DRAWING IS THE SOLE PROPERTY OF<br/>ALTINKAYA ENCLOSURES. ANY<br/>REPRODUCTION IN PART OR AS A WHOLE<br/>WITHOUT THE WRITTEN PERMISSION OF<br/>ALTINKAYA ENCLOSURES IS PROHIBITED.</small> |  | ARTICLE NO.:  | REVISION:   |
| <small>DRAWN</small> Dursun CAN  |  |  <small>ENCLOSURES FOR ELECTRONICS</small> | <small>CONTACT:</small><br><a href="http://www.altinkaya.com.tr">www.altinkaya.com.tr</a> |
| <small>CHECKED</small> Ali Altınışık   |  | <small>TITLE:</small><br><b>MountingDetail</b>  |   |
| <small>COMMENTS:</small>   |  | <small>DWG NO.</small>  | <b>A3</b>   |
| <small>MATERIAL:</small>   |  | <small>SCALE:</small> 1:1   | <small>SHEET</small> 1 OF 1   |
| <small>WEIGHT:</small>   |  |    |   |

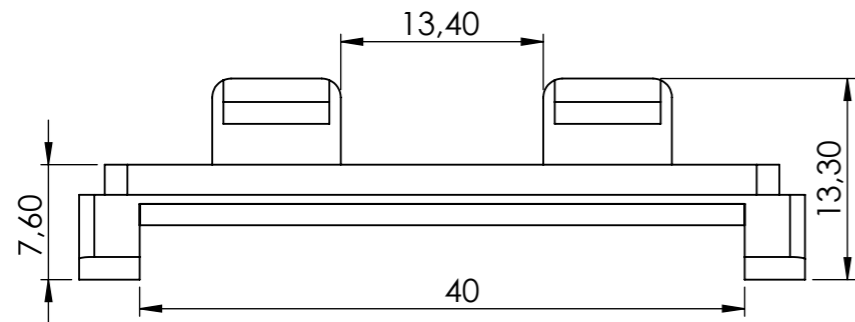
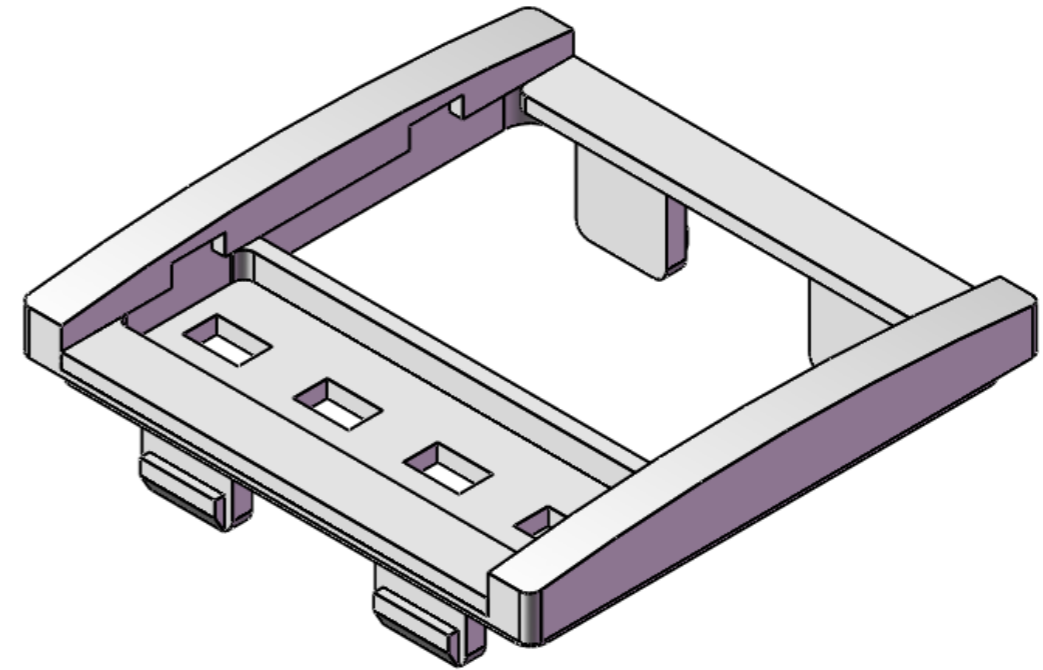
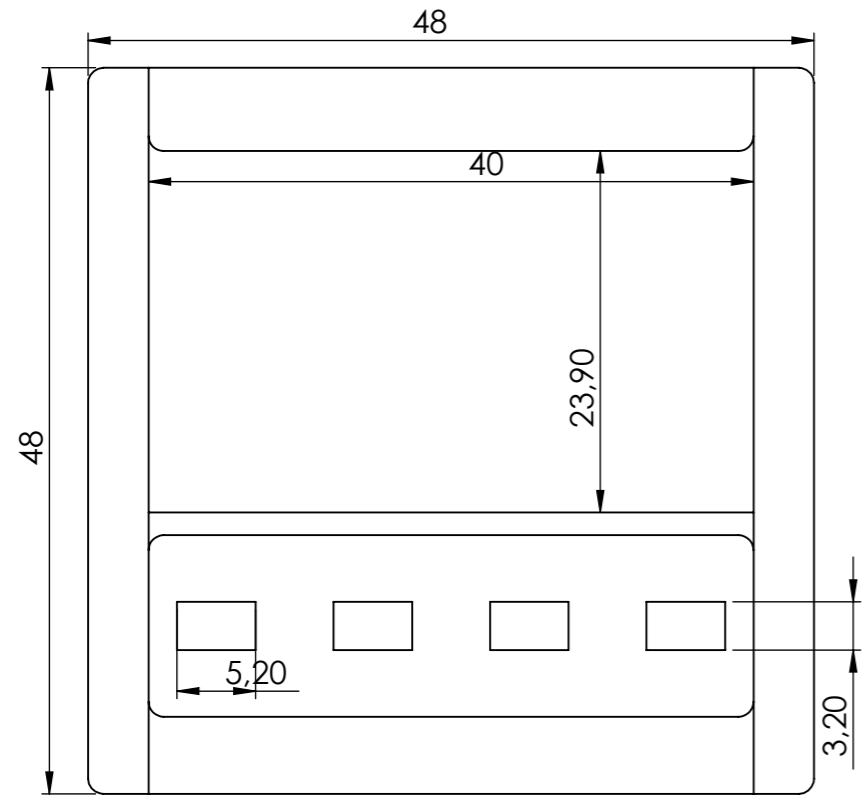

|   |               |      |  |           |                    |
|---|---------------|------|--|-----------|--------------------|
|   | NAME          | DATE | ARTICLE NO:  | REVISION: | TITLE:             |
| DRAWN   | Dursun CAN    |      |  |           |                    |
| CHECKED   | Ali Altınışık |      |  |           |                    |
| <br><b>www.altinkaya.com.tr</b>   |               |      | COMMENTS:<br>DIMENSIONS ARE IN MILLIMETERS.<br>DEBUR AND BREAK SHARP EDGES |           | DWG NO.            |
| PROPRIETARY AND CONFIDENTIAL<br><small>THE INFORMATION CONTAINED IN THIS DRAWING IS THE SOLE PROPERTY OF ALTINKAYA ENCLOSURES. ANY REPRODUCTION IN PART OR AS A WHOLE WITHOUT THE WRITTEN PERMISSION OF ALTINKAYA ENCLOSURES IS PROHIBITED.</small> |               |      | <b>MATERIAL:</b>   |           | <b>PT-140-Body</b> |
|   |               |      | WEIGHT:  |           | A4                 |
|   |               |      | SCALE:1:2  |           | SHEET 1 OF 1       |



|  |  |   |  |
|--|--|---|--|
| <small>PROPRIETARY AND CONFIDENTIAL<br/>THE INFORMATION CONTAINED IN THIS<br/>DRAWING IS THE SOLE PROPERTY OF<br/>ALTINKAYA ENCLOSURES. ANY<br/>REPRODUCTION IN PART OR AS A WHOLE<br/>WITHOUT THE WRITTEN PERMISSION OF<br/>ALTINKAYA ENCLOSURES IS PROHIBITED.</small> |  | ARTICLE NO.:  | REVISION:  |
| <small>DRAWN</small> Dursun CAN  |  |  | CONTACT:<br><a href="http://www.altinkaya.com.tr">www.altinkaya.com.tr</a> |
| <small>CHECKED</small> Ali Altınışık   |  |   | TITLE:   |
| <small>COMMENTS:</small>   |  | DWG NO.   | Pt-140-24-Panel  |
| <small>MATERIAL:</small>   |  | A3  |  |
| <small>WEIGHT:</small>   |  | SCALE:1:1   | SHEET 1 OF 1   |

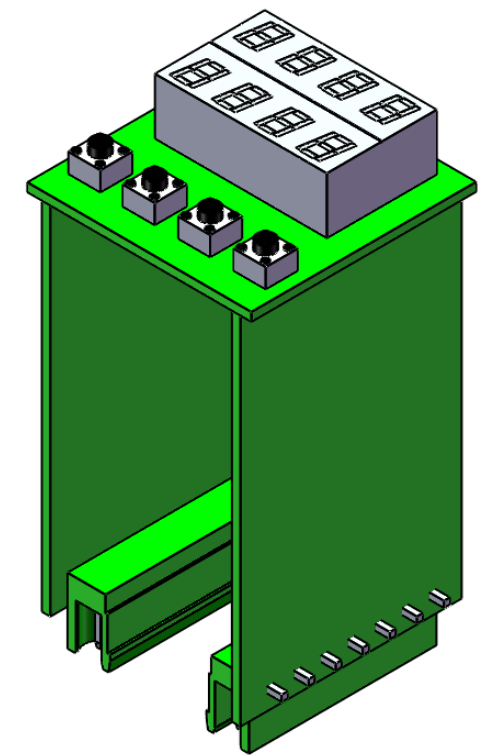
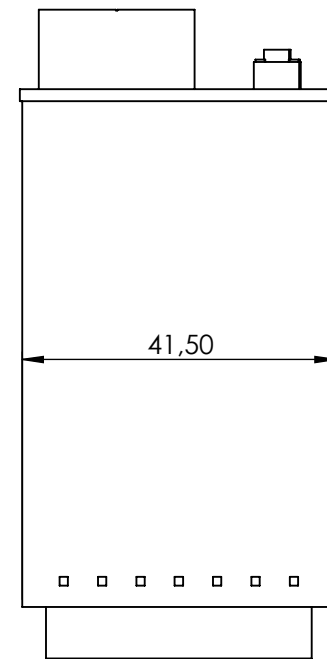
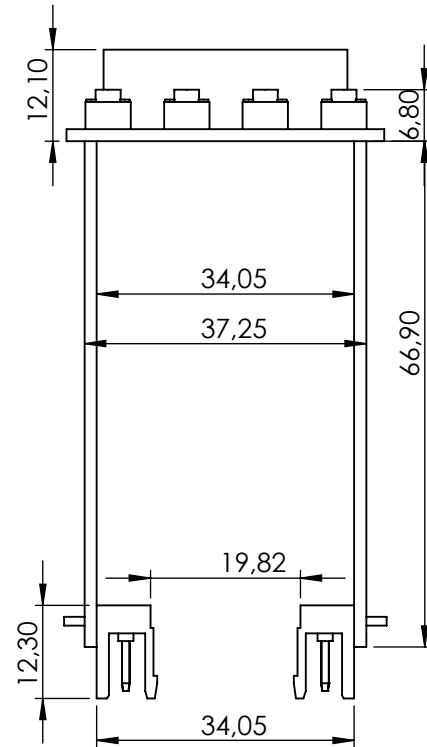
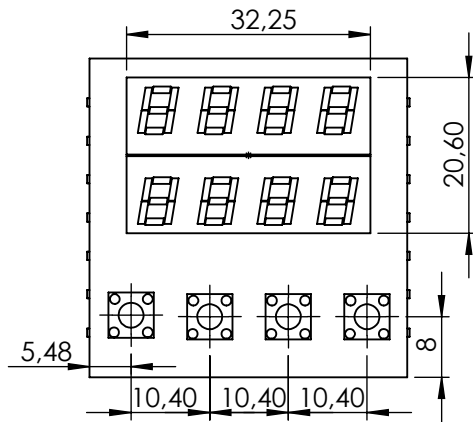

|  |               |      |  |           |              |
|--|---------------|------|--|-----------|--------------|
|  | NAME          | DATE | ARTICLE NO:  | REVISION: | TITLE:       |
| DRAWN  | Dursun CAN    |      |  |           |              |
| CHECKED  | Ali Altınışık |      | COMMENTS:<br>DIMENSIONS ARE IN MILLIMETERS.<br>DEBUR AND BREAK SHARP EDGES |           |              |
| <br><b>www.altinkaya.com.tr</b>  |               |      |  |           | DWG NO.      |
| <small>PROPRIETARY AND CONFIDENTIAL<br/>THE INFORMATION CONTAINED IN THIS DRAWING IS THE SOLE PROPERTY OF ALTINKAYA ENCLOSURES. ANY REPRODUCTION IN PART OR AS A WHOLE WITHOUT THE WRITTEN PERMISSION OF ALTINKAYA ENCLOSURES IS PROHIBITED.</small> |               |      | MATERIAL:  |           | PCB-DETAIL   |
|  |               |      | WEIGHT:  |           | A4           |
|  |               |      | SCALE:1:2  |           | SHEET 1 OF 1 |

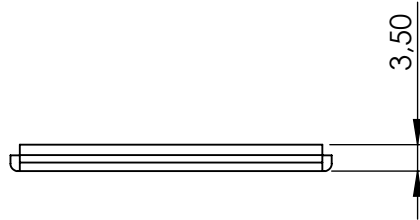
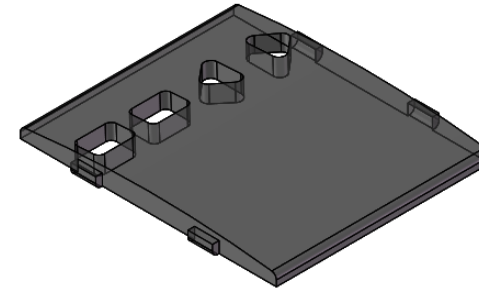
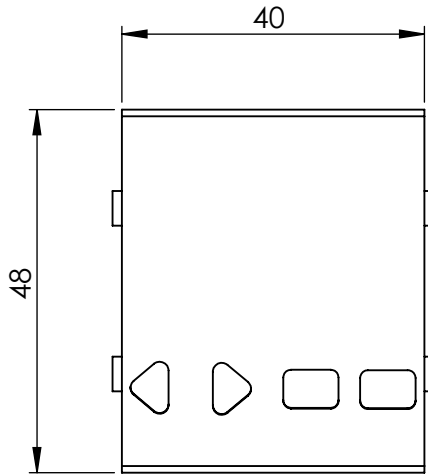

|  |               |      |   |           |              |
|--|---------------|------|---|-----------|--------------|
|  | NAME          | DATE | ARTICLE NO:   | REVISION: | TITLE:       |
| DRAWN  | Dursun CAN    |      |   |           |              |
| CHECKED  | Ali Altınışık |      | COMMENTS:   |           |              |
| <br><b>ALTINKAYA</b><br>ENCLOSURES FOR ELECTRONICS<br><a href="http://www.altinkaya.com.tr">www.altinkaya.com.tr</a>   |               |      | DIMENSIONS ARE IN MILLIMETERS.<br>DEBUR AND BREAK SHARP EDGES |           |              |
| <b>PROPRIETARY AND CONFIDENTIAL</b><br><small>THE INFORMATION CONTAINED IN THIS DRAWING IS THE SOLE PROPERTY OF ALTINKAYA ENCLOSURES. ANY REPRODUCTION IN PART OR AS A WHOLE WITHOUT THE WRITTEN PERMISSION OF ALTINKAYA ENCLOSURES IS PROHIBITED.</small> |               |      | DWG NO. <b>PT-140-25-GLASS</b>                                |           | A4           |
| <b>MATERIAL:</b>   |               |      | WEIGHT:   | SCALE:1:1 | SHEET 1 OF 1 |

